

限位开关

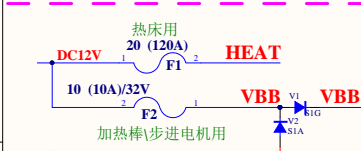

温度保险丝

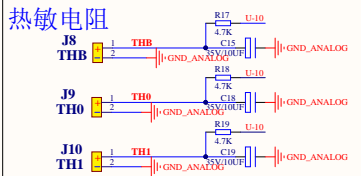
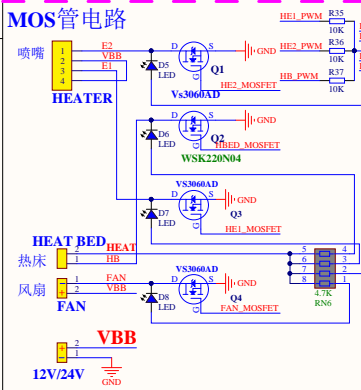
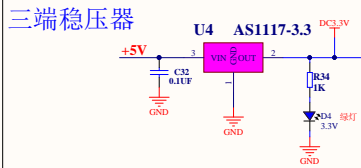
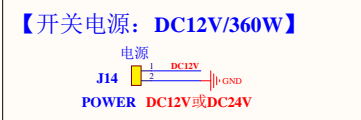

【OK】

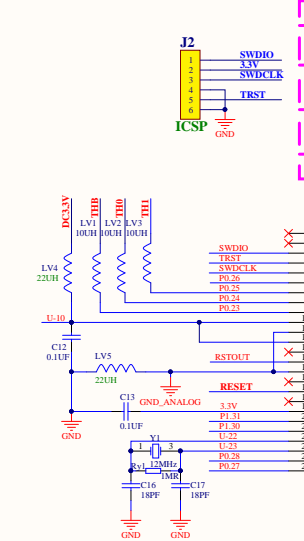

热敏电阻



【ARM主控】 【OK】

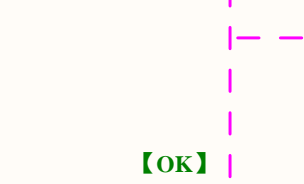
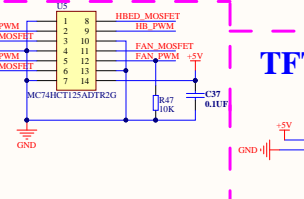
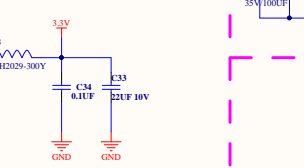
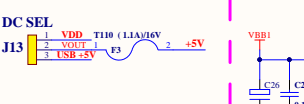

【OK】

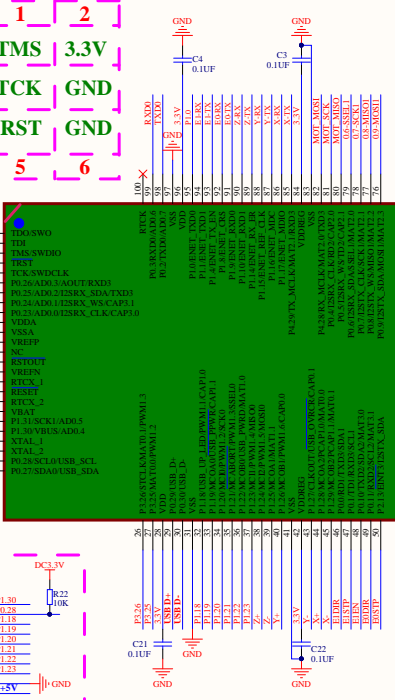

【ARM主控】 【OK】

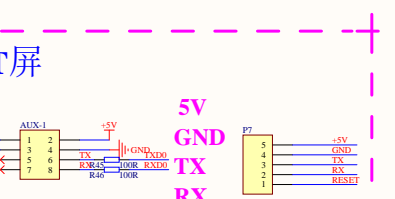
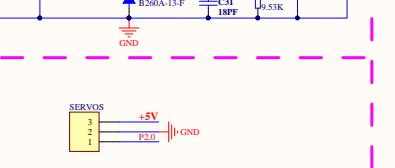
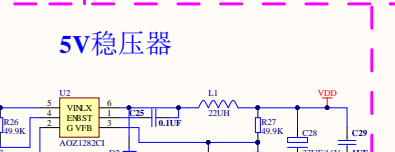

【OK】

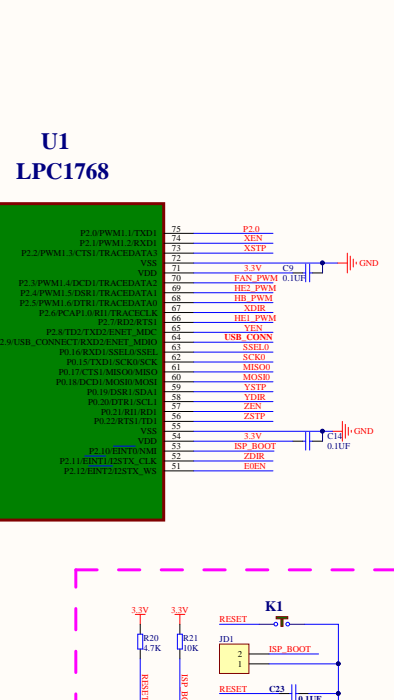

【ARM主控】 【OK】

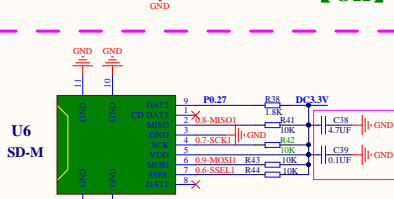
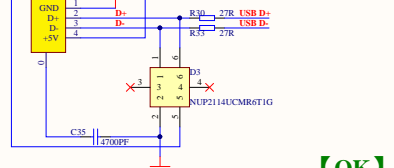
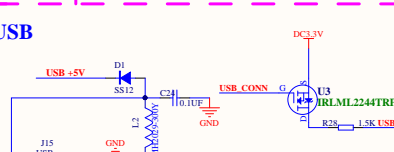

【OK】

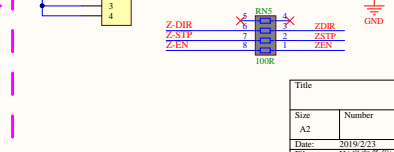
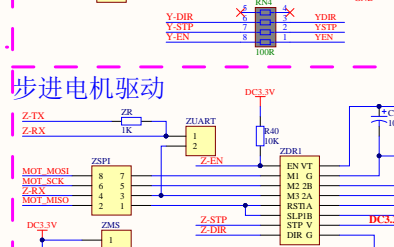
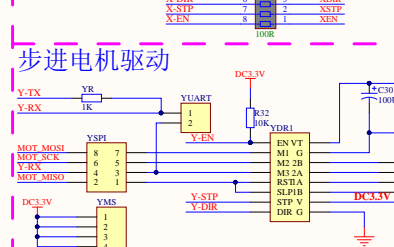
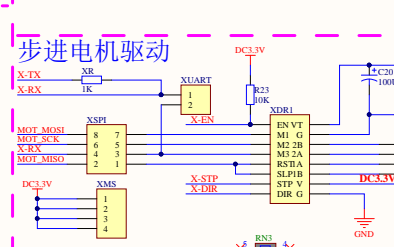
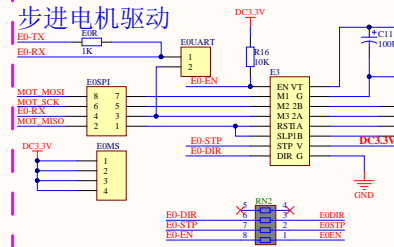
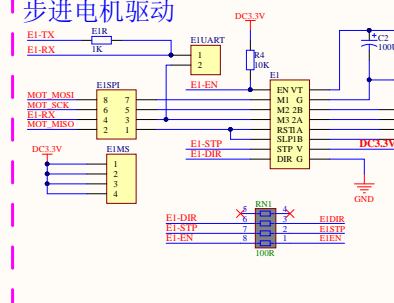

【OK】

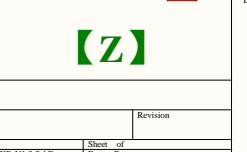
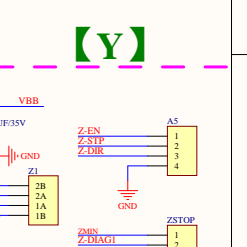
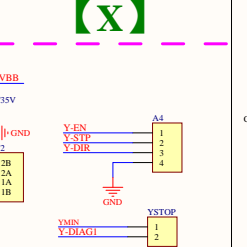
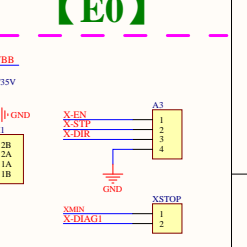
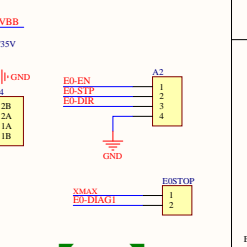
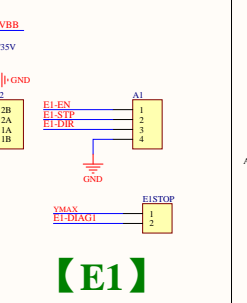

【OK】

SKR-V1.3主板

Title		
Size	Number	Revision
A2		
Date:	2019/2/23	Sheet of
File:	托架固件的_SKR-V1.3.SchDoc	Drawn By: